

GreenCobra®

LED Streetlights

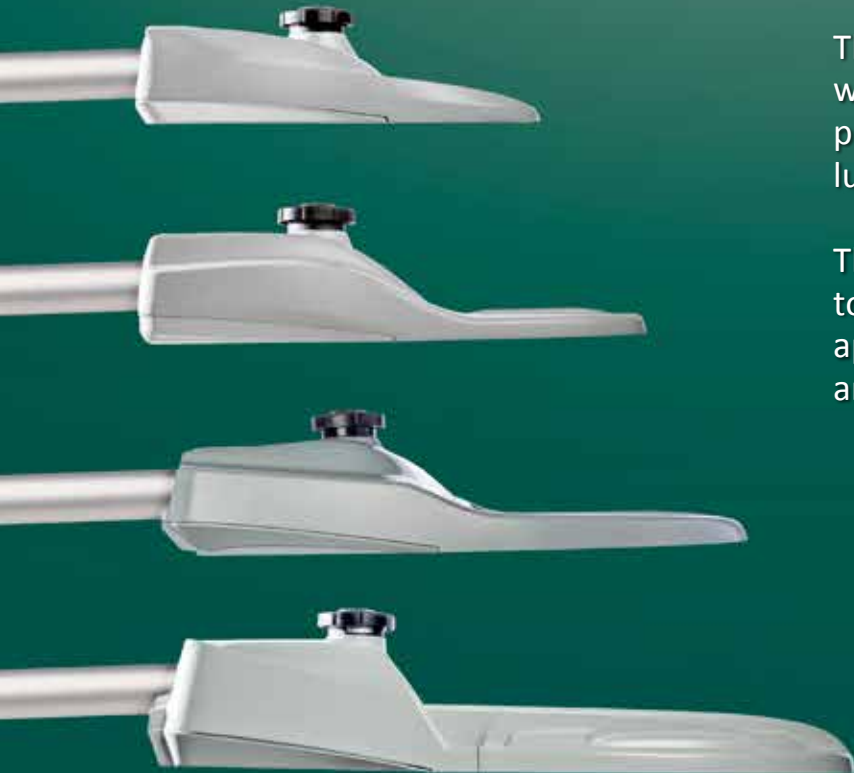

The GreenCobra series has received widespread approval and exhibited proven performance with over 3 million luminaires installed worldwide.

The series is available in four sizes to deliver the lumen packages and appropriate housing scale for virtually any street or roadway application.

LEOTEK®

www.leotek.com



Savannah, GA



Los Angeles, CA



Seattle, WA



California DOT (CalTrans)



Milpitas, CA



GreenCobra Series

Four sizes deliver the lumen packages and appropriate housing scale for multiple mounting heights:

G CJ



- Sized for residential street applications.
- Lumen package up to 14,400 lumens..

G CM



- Mid-size covers commercial and wider local streets.
- Lumen package up to 24,900 lumens.

G CL



- High lumen output for commercial intersections and high-speed roadways.
- Lumen package up to 35,600 lumens.

G C2



- High lumen output for commercial intersections and high-speed roadways.
- Lumen package up to 42,800 lumens.

HPS Equivalent Range

G CJ



Output Range

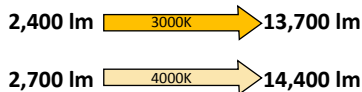

Dimensions

| Length | Width | Height |
|--------|-------|--------|
| 18.35" | 9.55" | 4.78" |
| 466mm | 243mm | 121mm |

G CM

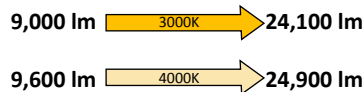

| Length | Width | Height |
|---------|---------|--------|
| 21.6" | 12.2" | 5.4" |
| 550.9mm | 310.3mm | 137mm |

G CL

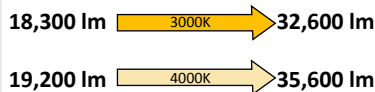

| Length | Width | Height |
|--------|-------|--------|
| 25.2" | 15.2" | 5.7" |
| 640mm | 386mm | 145mm |

G C2

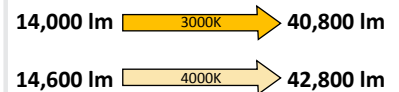
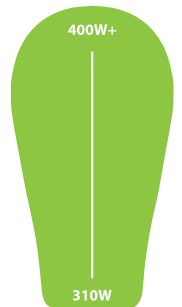

| Length | Width | Height |
|--------|--------|--------|
| 30.31" | 15.75" | 6.45" |
| 770mm | 400mm | 164mm |

LEOTEK believes that good design integrates simplicity and functionality. The GreenCobra Series is built with durable high-strength materials and reliable components, and is backed by LEOTEK USA's Standard 10-Year Warranty and 30 years of experience building LED lighting products.

Single-Cast Housing

The single-cast GreenCobra housing (GCJ, GCM, GCL) is made of corrosion-resistant aluminum and provides a continuous thermal path from the LED light engine to ambient air. This enables passive heat dissipation along the entire length of the luminaire.

This design approach makes it possible to introduce an elegant, low-profile luminaire without compromising efficiency.

All GreenCobra luminaires withstand the 5000-hour ASTM B-117 salt spray test through the use of low-copper content alloys and a robust Multi-stage polyester powder coat finish.



Coastal Paint Finish

Optional coastal finish per ASTM G85 to ensure longevity of the paint finish for installation within a mile of coastal area.



Vandal Resistant

GreenCobra Series offers a broad line of vandal resistant streetlights. GCJ, GCM and GCL models are all IK 10 rated, the highest rating for impact resistance. This includes the light engine optics, housing and access door which is made of a UL-rated polymer.



Robust, Efficient Light Engines

GreenCobra light engines are designed to draw less current than most designs in the industry. This provides maximum efficacy with less thermal stress for longer life. LEOTEK partners with premium LED vendors that use the latest material technology for long life operation. These high output LEDs produce a nominal 90% of initial output at 60,000 hours of life (IES recommended lumen maintenance life projection based on 6X the duration of LM-80 data.) LEOTEK uses LEDs that are ROHS compliant, 100% mercury and lead free.



GreenCobra light engines are constructed of durable optical polymer that is impact and UV resistant to ensure efficient light transmission over the life of the luminaire. The optical distributions are optimized to provide performance that is compliant with IESNA RP-8-18, even in challenging applications.

GreenCobra light engines utilize one-piece optics that are more efficient than optics that use flat tempered glass. With flat secondary cover glass, a significant percentage of light output is reflected back and never reaches the roadway.



GreenCobra IP-66 rated light engines use an array of discrete LEDs. There is less glare since the LED light sources are distributed, not concentrated in a small area like COB (chip-on-board) light engines.

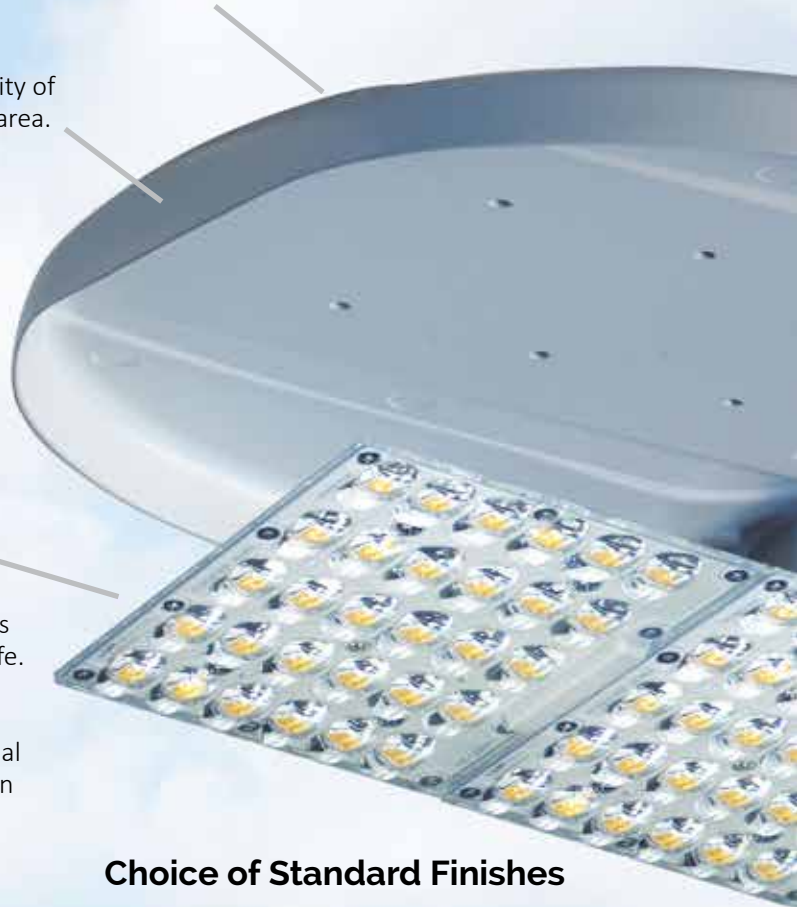

Choice of Standard Finishes

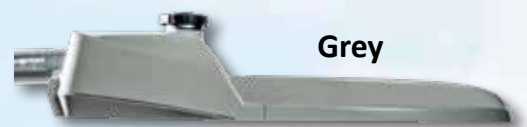

Grey



Dark Bronze



Black

Control Ready for Wireless Nodes

If you plan on installing wireless nodes immediately, we recommend that you specify the control ready option, PCR7-CR. If you do not plan on installing nodes until a later date, and you initially want the capability to field adjust light levels, you should specify PCR7.

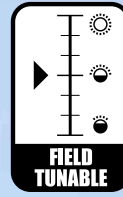

Light Level Control Options

The dimmable power supply enables field-adjustable light levels with the standard positive-lock current selector. Continuous dimming is also available on all GreenCobra luminaires using a wireless dimming node (supplied by others).



High Efficacy

LEOTEK's new J-Series offers up to 160 lm/W



Surge Protection

10kV/5kA with available 20kV/10kA per ANSI C136.2-2015

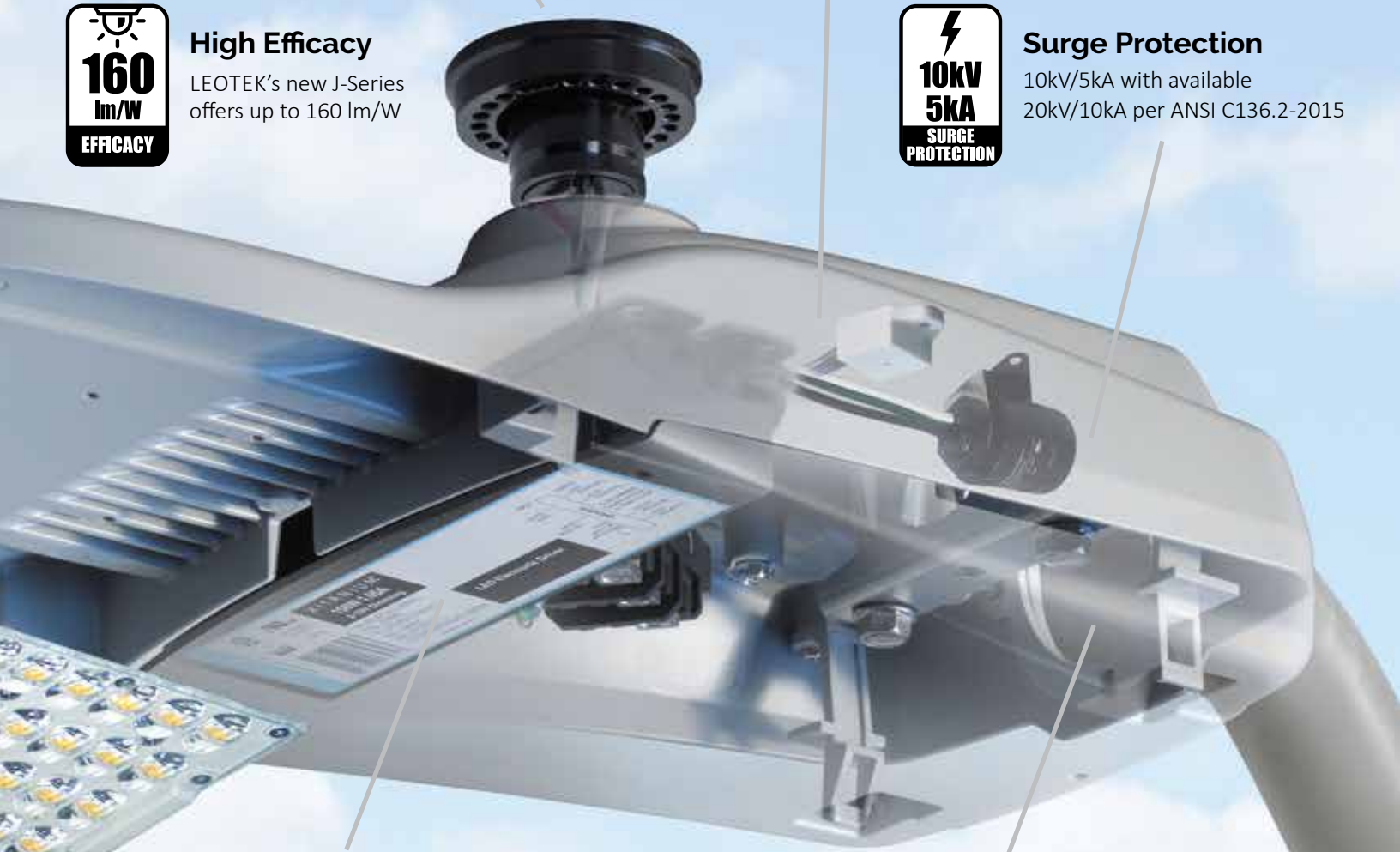

Power Supplies

GreenCobra luminaires are designed with power supplies that are rated for 100,000 hours of life with standard 1-10V dimming.



Wildlife Ingress Protection

All LEOTEK luminaires feature a Wildlife Guard. Our exclusive Rubber Wildlife Guard (RWG) is an option on GreenCobra GCJ, GCM, GCL and standard on GC2. This guard conforms to all standard mast arm sizes with no gaps and provides extra protection to ensure long life.



Rigorous Testing and Certification Process

Each GreenCobra luminaire is carefully assembled and tested at LEOTEK's USA facility in San Jose, California. The light engines are 100% tested prior to assembly. Every luminaire is 100% performance tested for proper light output and wattage after a 2-hour burn-in period.

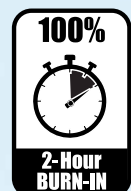

Distribution Types

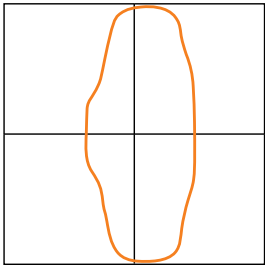

Type 2

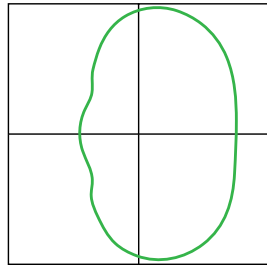

Type 3

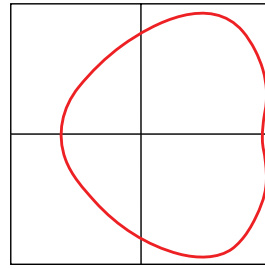

Type 4

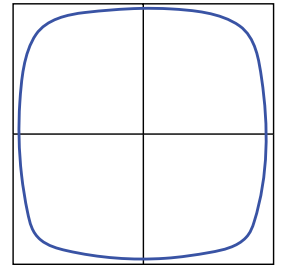

Type 5

NOTE: Please see product specification sheets to review photometrics available for each GreenCobra model.

Field-Tuning of Light Levels

GreenCobra luminaires include a standard dimmable 1-10V power supply with a positive-lock LED current selector. This enables end users to easily change light levels in the field if necessary. The positive-lock current selector ensures light levels aren't changed accidentally during installation.



Light Trespass Shielding

LEOTEK's snap-on shields may be purchased in either sets or individually and for either field or factory installation. Shields fit completely inside the housing profile and can be easily field installed. Refer to the GreenCobra Shield Installation Guide for details.

LEOTEK's Universal Light Trespass Shields Allow for Easy Snap-on Installation for GCJ, GCM and GCL Models

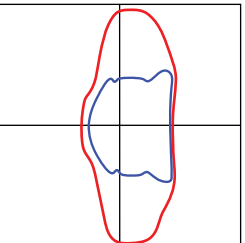
| Snap-on Front Side Shield (FSS) | Snap-on House Side Shield (HSS) | Snap-on Cul-de-Sac Shield (CSS) |
|--|--|---|
|  |  |  |
|   |   |   |

With Shield: ■ Without Shield: ■

Streetlight Control Options

PCR7 Option (ANSI C136.41 Compliant)

- Field-adjustable positive-lock current selector to change light output
- All factory output code settings available
- 1-10V leads factory-wired to current selector with molex style connectors
- Field-changeable connectors quickly enable wireless node dimming, if desired in the future
- Also accepts standard (3-wire) photocell

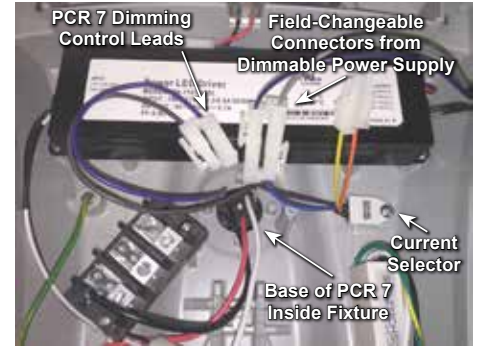

PCR7 Option

PCR7-CR Option (ANSI C136.41 Compliant)

- Lumen package and wattage set per output code in product specifications. Not able to adjust above specified output code.
- All factory output code settings available

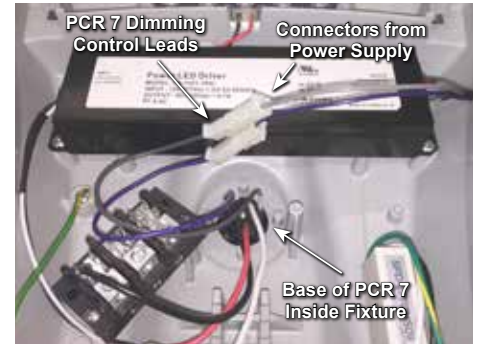

PCR7-CR Option



Standard 3-Wire Photocontrol Receptacle
Accepts Standard Photocell

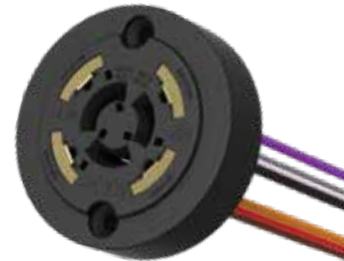

PCR7 and PCR7-CR Options

Accepts Wireless Control Node or Standard Photocell



Comparison Chart

| Option Code | Receptacle | Wireless Dimming Node Control-Ready | Requires Field Connections for Wireless Node | Supplied with Field-Adjustable Selector to Change Light Output |
|---|------------|-------------------------------------|--|--|
| Standard Photocontrol Receptacle^{1,2} | 3-Wire | N/A | N/A | Yes |
| PCR7² | 7-Wire | No | Yes | Yes |
| PCR7-CR³ | 7-Wire | Yes | No | No |

1. A 3-wire photocell is standard on GreenCobra luminaires.
 2. Current selector included to allow field selection of desired current to change light output.
 3. Furnished "control-ready" at factory for wireless node (by others).
 (Refer to specification sheet for complete details).

Visit LEOTEK.com to learn more about our innovative LED Lighting products



ComfortView™

ComfortView™ street lights utilize a new approach to address glare for neighborhood streets. Now neighborhoods can be beautifully lit with more visual comfort than first-generation LED luminaires while maintaining safety and energy efficiency. As with our other GreenCobra® LED Streetlights, ComfortView™ is built with durable high-strength materials and reliable components, and is backed by our 10-Year Warranty and 30 years of experience building LED lighting products.



Arieta®

Suited for numerous applications, including parking lots, campuses, office complexes, streets and public parks, Arieta® is universally retrofittable. Arieta is available in two housing sizes (AR-13 & AR-18) and a wide range of lumen packages to match the visual scale of multiple pole mounting heights.



Eseta™

Eseta's subtly distinctive form harmonizes with architecture without altering the building aesthetic. Eseta™ features ultra-high efficiency LED lighting greater than 100 lumens/watt, emergency battery system, two targeted distributions, innovative glare control, and motion sensor compatibility. Cold-weather rated for temperature range rating of -4°F to 140°F (-20°C to +60°C). An appealing and easy choice for retrofit applications.



LEOTEK Electronics USA LLC, located in California's Silicon Valley, is celebrating over thirty years as an LED lighting manufacturer, and is a leading supplier of LED streetlights worldwide. Globally recognized as a pioneer in light-emitting diode technology, and with millions of LED products installed worldwide, the company has a historical legacy of proven performance. LEOTEK offers innovative LED lighting products for applications encompassing traffic, transit, street, and area lighting. LEOTEK street and area lighting products are assembled in the USA.

1955 Lundy Ave., San Jose, CA 95131  408.380.1788

© 2023 LEOTEK Electronics USA. All Rights Reserved.
GreenCobra Overview_1-25-2023.
Specifications subject to change without notice.



To learn more visit www.leotek.com or contact a LEOTEK lighting agent 408.380.1788